

Data sheet | Item number: 2020-5372

3-conductor sensor supply terminal block; for PNP (positive) switching sensors; 1 mm²; Push-in CAGE CLAMP®; 1,00 mm²; orange

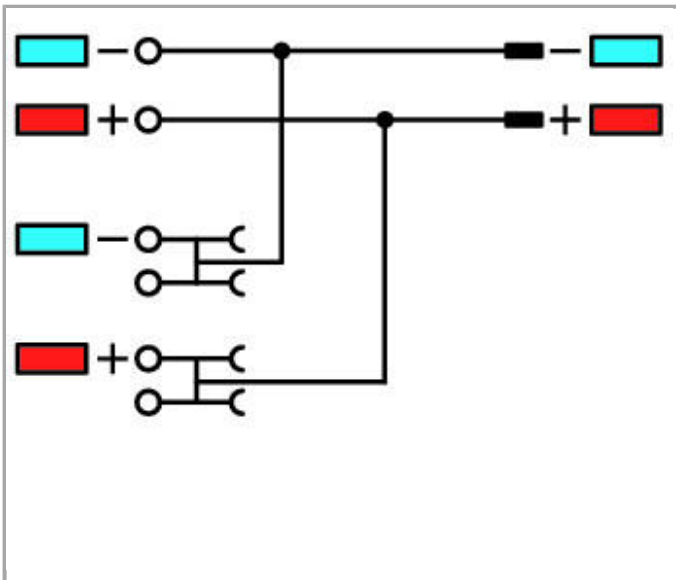

2020-5372

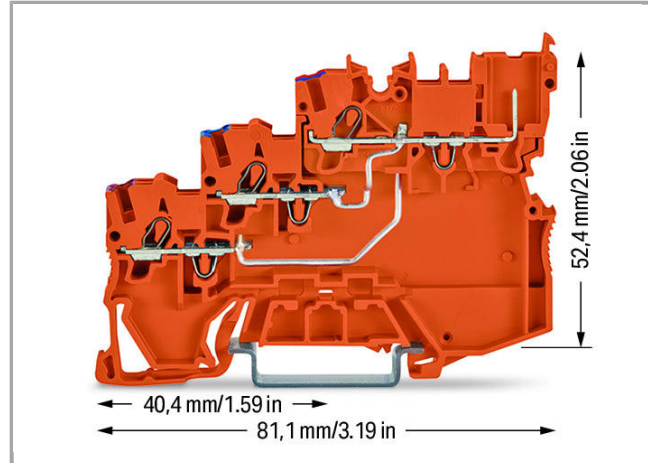

Item description

3.5 mm spacing per signal (2 x 3.5 mm = 7 mm)

The double spacing per pole of this terminal block series maximizes connectivity. For example, ten sensors may be connected using only five sensor terminal blocks plus a power supply terminal block.

Data

Electrical data

Ratings per IEC/EN 60664-1

Rated voltage (III / 3)	250 V
Rated impulse voltage (III / 3)	4 kV
Rated current	13.5 A

Approvals per UL 1059

Rated voltage UL (Use Group B)	300 V
Rated current UL (Use Group B)	15 A
Rated voltage UL (Use Group C)	300 V
Rated current UL (Use Group C)	15 A
Rated voltage UL (Use Group D)	300 V

Approvals per CSA

Rated voltage CSA (Use Group C)	300 V
Rated current CSA (Use Group C)	10 A

Connection data

Connection technology	Push-in CAGE CLAMP®
Actuation type	Push-in Open Tool Slot
Connectable conductor materials	Copper
Nominal cross section	1 mm ²
Solid conductor	0.14 1.5 mm ² / 24 16 AWG
Solid conductor, push-in termination	0.5 1.5 mm ² / 20 16 AWG
Fine-stranded conductor	0.14 1.5 mm ² / 24 16 AWG
Strip length	9 11 mm / 0.35 0.43 inch
Note (conductor cross-section)	Depending on the conductor characteristic, a conductor with a smaller cross section can also be inserted via push-in termination.
Total number of connection points	6
Total number of potentials	4
Type of wiring	Front-entry wiring

Geometrical Data

Width	7 mm / 0.276 inch
-------	-------------------

Height from upper-edge of DIN-35 rail	52.4 mm / 2.063 inch
Depth	81.1 mm / 3.193 inch

Mechanical data

Design	horizontal
Type of mounting	DIN-35 rail
Marking level	Center/side marking

Material Data



Color	orange
Insulating material	Polyamide 66 (PA 66)
Weight	15.898 g

Commercial data

Country of origin	DE
GTIN	4055143523820
Customs Tariff No.	85369010000

Approvals / Certificates

Radio-Approvals

Logo	Approval	Additional Approval Text	Certificate name
	CCA	EN 60947	NTR NL 7617
	CSA DEKRA Certification B.V.	C22.2 No. 158	2516073
	KEMA/KEUR DEKRA Certification B.V.	EN 60947	71- 100670

Country specific Approvals

Logo	Approval	Additional Approval Text	Certificate name
	CCA DEKRA Certification B.V.	EN 60947	NTR NL 7617
	CSA DEKRA Certification B.V.	C22.2 No. 158	2516073



KEMA/KEUR
DEKRA Certification B.V.

EN 60947

71-
100670

Other Approvals



Logo	Approval	Additional Approval Text	Certificate name
	UL UL International Germany GmbH	UL 1059	E45172

UL-Approvals

Logo	Approval	Additional Approval Text	Certificate name
	UL UL International Germany GmbH	UL 1059	E45172

















Compatible products



















tools











	Item no.: 210-647 Operating tool; Blade: 2.5 x 0.4 mm; with a partially insulated shaft	210-647
	Item no.: 210-648 Operating tool with partially insulated shaft; Blade (2.5 x 0.4) mm; short; angled	210-648
	Item no.: 210-719 Operating tool; Blade: 2.5 x 0.4 mm; with a partially insulated shaft	210-719











Marking accessories













	Item no.: 2009-110 Marking strips; on reel; not stretchable; plain; snap-on type; white	2009-110
--	---	----------









	Item no.: 2009-113 WMB-Inline; for Smart Printer; on reel; plain; snap-on type; white	2009-113
	Item no.: 2009-113/000-002 WMB-Inline; for Smart Printer; on reel; plain; snap-on type; yellow	2009-113 /000-002
	Item no.: 2009-113/000-005 WMB-Inline; for Smart Printer; on reel; plain; snap-on type; red	2009-113 /000-005
	Item no.: 2009-113/000-006 WMB-Inline; for Smart Printer; on reel; plain; snap-on type; blue	2009-113 /000-006
	Item no.: 2009-113/000-007 WMB-Inline; for Smart Printer; on reel; plain; snap-on type; gray	2009-113 /000-007
	Item no.: 2009-113/000-012 WMB-Inline; for Smart Printer; on reel; plain; snap-on type; orange	2009-113 /000-012
	Item no.: 2009-113/000-017 WMB-Inline; for Smart Printer; on reel; plain; snap-on type; light green	2009-113 /000-017
	Item no.: 2009-113/000-023 WMB-Inline; for Smart Printer; on reel; plain; snap-on type; green	2009-113 /000-023
	Item no.: 2009-113/000-024 WMB-Inline; for Smart Printer; on reel; plain; snap-on type; violet	2009-113 /000-024
	Item no.: 2009-191 Group marker carrier	2009-191
	Item no.: 793-3501 WMB marking card; as card; plain; snap-on type; white	793-3501
Protective Warning Marker		
	Item no.: 2000-115 Protective warning marker; with high-voltage symbol, black; for 5 terminal blocks; yellow	2000-115
check		
	Item no.: 2000-510 TOPJOB®S L-type test plug module; modular; for jumper contact slot; 1,00 mm ² ; gray	2000-510
	Item no.: 2000-552 Modular TOPJOB®S connector; modular; for jumper contact slot; 2-pole; 1,00 mm ² ; gray	2000-552
	Item no.: 2000-553 Modular TOPJOB®S connector; modular; for jumper contact slot; 3-pole; 1,00 mm ² ; gray	2000-553
	Item no.: 2000-554 Modular TOPJOB®S connector; modular; for jumper contact slot; 4-pole; 1,00 mm ² ; gray	2000-554









	Item no.: 2000-555 Modular TOPJOB®S connector; modular; for jumper contact slot; 5-pole; 1,00 mm ² ; gray	2000-555
	Item no.: 2000-556 Modular TOPJOB®S connector; modular; for jumper contact slot; 6-pole; 1,00 mm ² ; gray	2000-556
	Item no.: 2000-557 Modular TOPJOB®S connector; modular; for jumper contact slot; 7-pole; 1,00 mm ² ; gray	2000-557
	Item no.: 2000-558 Modular TOPJOB®S connector; modular; for jumper contact slot; 8-pole; 1,00 mm ² ; gray	2000-558
	Item no.: 2000-559 Modular TOPJOB®S connector; modular; for jumper contact slot; 9-pole; 1,00 mm ² ; gray	2000-559
	Item no.: 2000-560 Modular TOPJOB®S connector; modular; for jumper contact slot; 10-pole; 1,00 mm ² ; gray	2000-560
	Item no.: 2009-174 Test plug adapter; for 4 mm Ø test plugs; for testing TOPJOB®S rail-mounted terminal blocks; gray	2009-174
	Item no.: 2009-182 Testing tap; for max. 2.5 mm ² ; tool-free connection for individual test wires 0.08 - 2.5 mm; gray	2009-182
End plate		
	Item no.: 2020-5391 End and intermediate plate; 1 mm thick; for 3-conductor terminal blocks; gray	2020-5391
General accessories		
	Item no.: 2000-121 Adaptor	2000-121
	Item no.: 2020-161 Start module for 1-conductor female connector; with integrated end plate; 1.5 mm ² ; 1-pole; 1,50 mm ² ; gray	2020-161
	Item no.: 2020-164 Start module for 1-conductor female connector; with integrated end plate; 1.5 mm ² ; 1-pole; 1,50 mm ² ; blue	2020-164
	Item no.: 2020-167 Start module for 1-conductor female connector; 1.5 mm ² ; 1-pole; 1,50 mm ² ; green-yellow	2020-167
	Item no.: 2020-181 End module for 1-conductor female connector; 1.5 mm ² ; 1-pole; 1,50 mm ² ; gray	2020-181
	Item no.: 2020-184 End module for 1-conductor female connector; 1.5 mm ² ; 1-pole; 1,50 mm ² ; blue	2020-184
	Item no.: 2020-187 End module for 1-conductor female connector; 1.5 mm ² ; 1-pole; 1,50 mm ² ; green-yellow	2020-187
	Item no.: 2020-261 Start module for 2-conductor female connector; with integrated end plate; 1.5 mm ² ; 1-pole; 1,50 mm ² ; gray	2020-261
	Item no.: 2020-264 Start module for 2-conductor female connector; with integrated end plate; 1.5 mm ² ; 1-pole; 1,50 mm ² ; blue	2020-264









	Item no.: 2020-267 Start module for 2-conductor female connector; 1.5 mm ² ; 1-pole; 1,50 mm2; green-yellow	2020-267
	Item no.: 2020-281 End module for 2-conductor female connector; 1.5 mm ² ; 1-pole; 1,50 mm2; gray	2020-281
	Item no.: 2020-284 End module for 2-conductor female connector; 1.5 mm ² ; 1-pole; 1,50 mm2; blue	2020-284
	Item no.: 2020-287 End module for 2-conductor female connector; 1.5 mm ² ; 1-pole; 1,50 mm2; green-yellow	2020-287
Coding		
	Item no.: 2020-100 Carrier with 6 coding pins; for coding of female plugs; for carrier terminal blocks; orange	2020-100
Female plug		
	Item no.: 2020-102 1-conductor female plug; 1.5 mm ² ; 2-pole; 1,50 mm2; gray	2020-102
	Item no.: 2020-102/122-000 1-conductor female plug; Locking lever; 1.5 mm ² ; 2-pole; 1,50 mm2; gray	2020-102 / 122-000
	Item no.: 2020-102/132-000 1-conductor female plug; Strain relief plate; 1.5 mm ² ; 2-pole; 1,50 mm2; gray	2020-102 / 132-000
	Item no.: 2020-102/142-000 1-conductor female plug; Strain relief plate; 1.5 mm ² ; 2-pole; 1,50 mm2; gray	2020-102 / 142-000
	Item no.: 2020-103 1-conductor female plug; 1.5 mm ² ; 3-pole; 1,50 mm2; gray	2020-103
	Item no.: 2020-103/000-036 1-conductor female plug; 1.5 mm ² ; 3-pole; 1,50 mm2; gray, green-yellow	2020-103 / 000-036
	Item no.: 2020-103/000-037 1-conductor female plug; 1.5 mm ² ; 3-pole; 1,50 mm2; green-yellow, gray	2020-103 / 000-037
	Item no.: 2020-103/000-038 1-conductor female plug; 1.5 mm ² ; 3-pole; 1,50 mm2; gray, blue, green-yellow	2020-103 / 000-038
	Item no.: 2020-103/000-039 1-conductor female plug; 1.5 mm ² ; 3-pole; 1,50 mm2; green-yellow, blue, gray	2020-103 / 000-039
	Item no.: 2020-103/122-000 1-conductor female plug; Locking lever; 1.5 mm ² ; 3-pole; 1,50 mm2; gray	2020-103 / 122-000
	Item no.: 2020-103/132-000 1-conductor female plug; Strain relief plate; 1.5 mm ² ; 3-pole; 1,50 mm2; gray	2020-103 / 132-000









	Item no.: 2020-103/142-000 1-conductor female plug; Strain relief plate; 1.5 mm ² ; 3-pole; 1,50 mm ² ; gray	/ 142-000	2020-103
	Item no.: 2020-104 1-conductor female plug; 1.5 mm ² ; 4-pole; 1,50 mm ² ; gray		2020-104
	Item no.: 2020-104/000-036 1-conductor female plug; 1.5 mm ² ; 4-pole; 1,50 mm ² ; gray, green-yellow	/ 000-036	2020-104
	Item no.: 2020-104/000-037 1-conductor female plug; 1.5 mm ² ; 4-pole; 1,50 mm ² ; green-yellow, gray	/ 000-037	2020-104
	Item no.: 2020-104/000-038 1-conductor female plug; 1.5 mm ² ; 4-pole; 1,50 mm ² ; gray, blue, green-yellow	/ 000-038	2020-104
	Item no.: 2020-104/000-039 1-conductor female plug; 1.5 mm ² ; 4-pole; 1,50 mm ² ; green-yellow, blue, gray	/ 000-039	2020-104
	Item no.: 2020-104/124-000 1-conductor female plug; Locking lever; 1.5 mm ² ; 4-pole; 1,50 mm ² ; gray	/ 124-000	2020-104
	Item no.: 2020-104/133-000 1-conductor female plug; Strain relief plate; 1.5 mm ² ; 4-pole; 1,50 mm ² ; gray	/ 133-000	2020-104
	Item no.: 2020-104/143-000 1-conductor female plug; Strain relief plate; 1.5 mm ² ; 4-pole; 1,50 mm ² ; gray	/ 143-000	2020-104
	Item no.: 2020-105 1-conductor female plug; 1.5 mm ² ; 5-pole; 1,50 mm ² ; gray		2020-105
	Item no.: 2020-105/000-036 1-conductor female plug; 1.5 mm ² ; 5-pole; 1,50 mm ² ; gray, green-yellow	/ 000-036	2020-105
	Item no.: 2020-105/000-037 1-conductor female plug; 1.5 mm ² ; 5-pole; 1,50 mm ² ; green-yellow, gray	/ 000-037	2020-105
	Item no.: 2020-105/000-038 1-conductor female plug; 1.5 mm ² ; 5-pole; 1,50 mm ² ; gray, blue, green-yellow	/ 000-038	2020-105
	Item no.: 2020-105/000-039 1-conductor female plug; 1.5 mm ² ; 5-pole; 1,50 mm ² ; green-yellow, blue, gray	/ 000-039	2020-105
	Item no.: 2020-105/124-000 1-conductor female plug; Locking lever; 1.5 mm ² ; 5-pole; 1,50 mm ² ; gray	/ 124-000	2020-105













	Item no.: 2020-105/133-000 1-conductor female plug; Strain relief plate; 1.5 mm ² ; 5-pole; 1,50 mm ² ; gray	/ 133-000	2020-105
	Item no.: 2020-105/143-000 1-conductor female plug; Strain relief plate; 1.5 mm ² ; 5-pole; 1,50 mm ² ; gray	/ 143-000	2020-105
	Item no.: 2020-106 1-conductor female plug; 1.5 mm ² ; 6-pole; 1,50 mm ² ; gray		2020-106
	Item no.: 2020-106/000-036 1-conductor female plug; 1.5 mm ² ; 6-pole; 1,50 mm ² ; gray, green-yellow	/ 000-036	2020-106
	Item no.: 2020-106/000-037 1-conductor female plug; 1.5 mm ² ; 6-pole; 1,50 mm ² ; green-yellow, gray	/ 000-037	2020-106
	Item no.: 2020-106/000-038 1-conductor female plug; 1.5 mm ² ; 6-pole; 1,50 mm ² ; gray, blue, green-yellow	/ 000-038	2020-106
	Item no.: 2020-106/000-039 1-conductor female plug; 1.5 mm ² ; 6-pole; 1,50 mm ² ; green-yellow, blue, gray	/ 000-039	2020-106
	Item no.: 2020-106/124-000 1-conductor female plug; Locking lever; 1.5 mm ² ; 6-pole; 1,50 mm ² ; gray	/ 124-000	2020-106
	Item no.: 2020-106/133-000 1-conductor female plug; Strain relief plate; 1.5 mm ² ; 6-pole; 1,50 mm ² ; gray	/ 133-000	2020-106
	Item no.: 2020-106/143-000 1-conductor female plug; Strain relief plate; 1.5 mm ² ; 6-pole; 1,50 mm ² ; gray	/ 143-000	2020-106
	Item no.: 2020-107 1-conductor female plug; 1.5 mm ² ; 7-pole; 1,50 mm ² ; gray		2020-107
	Item no.: 2020-107/000-036 1-conductor female plug; 1.5 mm ² ; 7-pole; 1,50 mm ² ; gray, green-yellow	/ 000-036	2020-107
	Item no.: 2020-107/000-037 1-conductor female plug; 1.5 mm ² ; 7-pole; 1,50 mm ² ; green-yellow, gray	/ 000-037	2020-107
	Item no.: 2020-107/000-038 1-conductor female plug; 1.5 mm ² ; 7-pole; 1,50 mm ² ; gray, blue, green-yellow	/ 000-038	2020-107
	Item no.: 2020-107/000-039 1-conductor female plug; 1.5 mm ² ; 7-pole; 1,50 mm ² ; green-yellow, blue, gray	/ 000-039	2020-107















	Item no.: 2020-107/124-000 1-conductor female plug; Locking lever; 1.5 mm ² ; 7-pole; 1,50 mm ² ; gray	/ 124-000	2020-107
	Item no.: 2020-107/134-000 1-conductor female plug; Strain relief plate; 1.5 mm ² ; 7-pole; 1,50 mm ² ; gray	/ 134-000	2020-107
	Item no.: 2020-107/144-000 1-conductor female plug; Strain relief plate; 1.5 mm ² ; 7-pole; 1,50 mm ² ; gray	/ 144-000	2020-107
	Item no.: 2020-108 1-conductor female plug; 1.5 mm ² ; 8-pole; 1,50 mm ² ; gray		2020-108
	Item no.: 2020-108/000-036 1-conductor female plug; 1.5 mm ² ; 8-pole; 1,50 mm ² ; gray, green-yellow	/ 000-036	2020-108
	Item no.: 2020-108/000-037 1-conductor female plug; 1.5 mm ² ; 8-pole; 1,50 mm ² ; green-yellow, gray	/ 000-037	2020-108
	Item no.: 2020-108/000-038 1-conductor female plug; 1.5 mm ² ; 8-pole; 1,50 mm ² ; gray, blue, green-yellow	/ 000-038	2020-108
	Item no.: 2020-108/000-039 1-conductor female plug; 1.5 mm ² ; 8-pole; 1,50 mm ² ; green-yellow, blue, gray	/ 000-039	2020-108
	Item no.: 2020-108/124-000 1-conductor female plug; Locking lever; 1.5 mm ² ; 8-pole; 1,50 mm ² ; gray	/ 124-000	2020-108
	Item no.: 2020-108/134-000 1-conductor female plug; Strain relief plate; 1.5 mm ² ; 8-pole; 1,50 mm ² ; gray	/ 134-000	2020-108
	Item no.: 2020-108/144-000 1-conductor female plug; Strain relief plate; 1.5 mm ² ; 8-pole; 1,50 mm ² ; gray	/ 144-000	2020-108
	Item no.: 2020-109 1-conductor female plug; 1.5 mm ² ; 9-pole; 1,50 mm ² ; gray		2020-109
	Item no.: 2020-109/000-036 1-conductor female plug; 1.5 mm ² ; 9-pole; 1,50 mm ² ; gray, green-yellow	/ 000-036	2020-109
	Item no.: 2020-109/000-037 1-conductor female plug; 1.5 mm ² ; 9-pole; 1,50 mm ² ; green-yellow, gray	/ 000-037	2020-109
	Item no.: 2020-109/000-038 1-conductor female plug; 1.5 mm ² ; 9-pole; 1,50 mm ² ; gray, blue, green-yellow	/ 000-038	2020-109















	Item no.: 2020-109/000-039 1-conductor female plug; 1.5 mm ² ; 9-pole; 1,50 mm ² ; green-yellow, blue, gray	/000-039	2020-109
	Item no.: 2020-109/124-000 1-conductor female plug; Locking lever; 1.5 mm ² ; 9-pole; 1,50 mm ² ; gray	/124-000	2020-109
	Item no.: 2020-109/134-000 1-conductor female plug; Strain relief plate; 1.5 mm ² ; 9-pole; 1,50 mm ² ; gray	/134-000	2020-109
	Item no.: 2020-109/144-000 1-conductor female plug; Strain relief plate; 1.5 mm ² ; 9-pole; 1,50 mm ² ; gray	/144-000	2020-109
	Item no.: 2020-110 1-conductor female plug; 1.5 mm ² ; 10-pole; 1,50 mm ² ; gray		2020-110
	Item no.: 2020-110/000-036 1-conductor female plug; 1.5 mm ² ; 10-pole; 1,50 mm ² ; gray, green-yellow	/000-036	2020-110
	Item no.: 2020-110/000-037 1-conductor female plug; 1.5 mm ² ; 10-pole; 1,50 mm ² ; green-yellow, gray	/000-037	2020-110
	Item no.: 2020-110/000-038 1-conductor female plug; 1.5 mm ² ; 10-pole; 1,50 mm ² ; gray, blue, green-yellow	/000-038	2020-110
	Item no.: 2020-110/000-039 1-conductor female plug; 1.5 mm ² ; 10-pole; 1,50 mm ² ; green-yellow, blue, gray	/000-039	2020-110
	Item no.: 2020-110/125-000 1-conductor female plug; Locking lever; 1.5 mm ² ; 10-pole; 1,50 mm ² ; gray	/125-000	2020-110
	Item no.: 2020-110/135-000 1-conductor female plug; Strain relief plate; 1.5 mm ² ; 10-pole; 1,50 mm ² ; gray	/135-000	2020-110
	Item no.: 2020-110/145-000 1-conductor female plug; Strain relief plate; 1.5 mm ² ; 10-pole; 1,50 mm ² ; gray	/145-000	2020-110
	Item no.: 2020-111 1-conductor female plug; 1.5 mm ² ; 11-pole; 1,50 mm ² ; gray		2020-111
	Item no.: 2020-111/000-036 1-conductor female plug; 1.5 mm ² ; 11-pole; 1,50 mm ² ; gray, green-yellow	/000-036	2020-111
	Item no.: 2020-111/000-037 1-conductor female plug; 1.5 mm ² ; 11-pole; 1,50 mm ² ; green-yellow, gray	/000-037	2020-111















	Item no.: 2020-111/000-038 1-conductor female plug; 1.5 mm ² ; 11-pole; 1,50 mm ² ; gray, blue, green-yellow	/000-038	2020-111
	Item no.: 2020-111/000-039 1-conductor female plug; 1.5 mm ² ; 11-pole; 1,50 mm ² ; green-yellow, blue, gray	/000-039	2020-111
	Item no.: 2020-111/125-000 1-conductor female plug; Locking lever; 1.5 mm ² ; 11-pole; 1,50 mm ² ; gray	/125-000	2020-111
	Item no.: 2020-111/135-000 1-conductor female plug; Strain relief plate; 1.5 mm ² ; 11-pole; 1,50 mm ² ; gray	/135-000	2020-111
	Item no.: 2020-111/145-000 1-conductor female plug; Strain relief plate; 1.5 mm ² ; 11-pole; 1,50 mm ² ; gray	/145-000	2020-111
	Item no.: 2020-112 1-conductor female plug; 1.5 mm ² ; 12-pole; 1,50 mm ² ; gray		2020-112
	Item no.: 2020-112/000-036 1-conductor female plug; 1.5 mm ² ; 12-pole; 1,50 mm ² ; gray, green-yellow	/000-036	2020-112
	Item no.: 2020-112/000-037 1-conductor female plug; 1.5 mm ² ; 12-pole; 1,50 mm ² ; green-yellow, gray	/000-037	2020-112
	Item no.: 2020-112/000-038 1-conductor female plug; 1.5 mm ² ; 12-pole; 1,50 mm ² ; gray, blue, green-yellow	/000-038	2020-112
	Item no.: 2020-112/000-039 1-conductor female plug; 1.5 mm ² ; 12-pole; 1,50 mm ² ; green-yellow, blue, gray	/000-039	2020-112
	Item no.: 2020-112/125-000 1-conductor female plug; Locking lever; 1.5 mm ² ; 12-pole; 1,50 mm ² ; gray	/125-000	2020-112
	Item no.: 2020-112/135-000 1-conductor female plug; Strain relief plate; 1.5 mm ² ; 12-pole; 1,50 mm ² ; gray	/135-000	2020-112
	Item no.: 2020-112/145-000 1-conductor female plug; Strain relief plate; 1.5 mm ² ; 12-pole; 1,50 mm ² ; gray	/145-000	2020-112
	Item no.: 2020-113 1-conductor female plug; 1.5 mm ² ; 13-pole; 1,50 mm ² ; gray		2020-113
	Item no.: 2020-113/000-036 1-conductor female plug; 1.5 mm ² ; 13-pole; 1,50 mm ² ; gray, green-yellow	/000-036	2020-113















	Item no.: 2020-113/000-037 1-conductor female plug; 1.5 mm ² ; 13-pole; 1,50 mm2; green-yellow, gray	/000-037	2020-113
	Item no.: 2020-113/000-038 1-conductor female plug; 1.5 mm ² ; 13-pole; 1,50 mm2; gray, blue, green-yellow	/000-038	2020-113
	Item no.: 2020-113/000-039 1-conductor female plug; 1.5 mm ² ; 13-pole; 1,50 mm2; green-yellow, blue, gray	/000-039	2020-113
	Item no.: 2020-113/125-000 1-conductor female plug; Locking lever; 1.5 mm ² ; 13-pole; 1,50 mm2; gray	/125-000	2020-113
	Item no.: 2020-113/135-000 1-conductor female plug; Strain relief plate; 1.5 mm ² ; 13-pole; 1,50 mm2; gray	/135-000	2020-113
	Item no.: 2020-113/145-000 1-conductor female plug; Strain relief plate; 1.5 mm ² ; 13-pole; 1,50 mm2; gray	/145-000	2020-113
	Item no.: 2020-114 1-conductor female plug; 1.5 mm ² ; 14-pole; 1,50 mm2; gray		2020-114
	Item no.: 2020-114/000-036 1-conductor female plug; 1.5 mm ² ; 14-pole; 1,50 mm2; gray, green-yellow	/000-036	2020-114
	Item no.: 2020-114/000-037 1-conductor female plug; 1.5 mm ² ; 14-pole; 1,50 mm2; green-yellow, gray	/000-037	2020-114
	Item no.: 2020-114/000-038 1-conductor female plug; 1.5 mm ² ; 14-pole; 1,50 mm2; gray, blue, green-yellow	/000-038	2020-114
	Item no.: 2020-114/000-039 1-conductor female plug; 1.5 mm ² ; 14-pole; 1,50 mm2; green-yellow, blue, gray	/000-039	2020-114
	Item no.: 2020-114/125-000 1-conductor female plug; Locking lever; 1.5 mm ² ; 14-pole; 1,50 mm2; gray	/125-000	2020-114
	Item no.: 2020-114/135-000 1-conductor female plug; Strain relief plate; 1.5 mm ² ; 14-pole; 1,50 mm2; gray	/135-000	2020-114
	Item no.: 2020-114/145-000 1-conductor female plug; Strain relief plate; 1.5 mm ² ; 14-pole; 1,50 mm2; gray	/145-000	2020-114
	Item no.: 2020-115 1-conductor female plug; 1.5 mm ² ; 15-pole; 1,50 mm2; gray		2020-115

















	Item no.: 2020-115/000-036 1-conductor female plug; 1.5 mm ² ; 15-pole; 1,50 mm2; gray, green-yellow	2020-115
		/000-036
	Item no.: 2020-115/000-037 1-conductor female plug; 1.5 mm ² ; 15-pole; 1,50 mm2; green-yellow, gray	2020-115
		/000-037
	Item no.: 2020-115/000-038 1-conductor female plug; 1.5 mm ² ; 15-pole; 1,50 mm2; gray, blue, green-yellow	2020-115
		/000-038
	Item no.: 2020-115/000-039 1-conductor female plug; 1.5 mm ² ; 15-pole; 1,50 mm2; green-yellow, blue, gray	2020-115
		/000-039
	Item no.: 2020-115/125-000 1-conductor female plug; Locking lever; 1.5 mm ² ; 15-pole; 1,50 mm2; gray	2020-115
		/125-000
	Item no.: 2020-115/135-000 1-conductor female plug; Strain relief plate; 1.5 mm ² ; 15-pole; 1,50 mm2; gray	2020-115
		/135-000
	Item no.: 2020-115/145-000 1-conductor female plug; Strain relief plate; 1.5 mm ² ; 15-pole; 1,50 mm2; gray	2020-115
		/145-000
	Item no.: 2020-202 2-conductor female connector; 1.5 mm ² ; 2-pole; 1,50 mm2; gray	2020-202
	Item no.: 2020-203 2-conductor female connector; 1.5 mm ² ; 3-pole; 1,50 mm2; gray	2020-203
	Item no.: 2020-203/000-036 2-conductor female connector; 1.5 mm ² ; 3-pole; 1,50 mm2; gray, green-yellow	2020-203
		/000-036
	Item no.: 2020-203/000-037 2-conductor female connector; 1.5 mm ² ; 3-pole; 1,50 mm2; green-yellow, gray	2020-203
		/000-037
	Item no.: 2020-203/000-038 2-conductor female connector; 1.5 mm ² ; 3-pole; 1,50 mm2; gray, blue, green-yellow	2020-203
		/000-038
	Item no.: 2020-203/000-039 2-conductor female connector; 1.5 mm ² ; 3-pole; 1,50 mm2; green-yellow, blue, gray	2020-203
		/000-039
	Item no.: 2020-204 2-conductor female connector; 1.5 mm ² ; 4-pole; 1,50 mm2; gray	2020-204
	Item no.: 2020-204/000-036 2-conductor female connector; 1.5 mm ² ; 4-pole; 1,50 mm2; gray, green-yellow	2020-204
		/000-036

















	Item no.: 2020-204/000-037 2-conductor female connector; 1.5 mm ² ; 4-pole; 1,50 mm ² ; green-yellow, gray	/000-037	2020-204
	Item no.: 2020-204/000-038 2-conductor female connector; 1.5 mm ² ; 4-pole; 1,50 mm ² ; gray, blue, green-yellow	/000-038	2020-204
	Item no.: 2020-204/000-039 2-conductor female connector; 1.5 mm ² ; 4-pole; 1,50 mm ² ; green-yellow, blue, gray	/000-039	2020-204
	Item no.: 2020-205 2-conductor female connector; 1.5 mm ² ; 5-pole; 1,50 mm ² ; gray		2020-205
	Item no.: 2020-205/000-036 2-conductor female connector; 1.5 mm ² ; 5-pole; 1,50 mm ² ; gray, green-yellow	/000-036	2020-205
	Item no.: 2020-205/000-037 2-conductor female connector; 1.5 mm ² ; 5-pole; 1,50 mm ² ; green-yellow, gray	/000-037	2020-205
	Item no.: 2020-205/000-038 2-conductor female connector; 1.5 mm ² ; 5-pole; 1,50 mm ² ; gray, blue, green-yellow	/000-038	2020-205
	Item no.: 2020-205/000-039 2-conductor female connector; 1.5 mm ² ; 5-pole; 1,50 mm ² ; green-yellow, blue, gray	/000-039	2020-205
	Item no.: 2020-206 2-conductor female connector; 1.5 mm ² ; 6-pole; 1,50 mm ² ; gray		2020-206
	Item no.: 2020-206/000-036 2-conductor female connector; 1.5 mm ² ; 6-pole; 1,50 mm ² ; gray, green-yellow	/000-036	2020-206
	Item no.: 2020-206/000-037 2-conductor female connector; 1.5 mm ² ; 6-pole; 1,50 mm ² ; green-yellow, gray	/000-037	2020-206
	Item no.: 2020-206/000-038 2-conductor female connector; 1.5 mm ² ; 6-pole; 1,50 mm ² ; gray, blue, green-yellow	/000-038	2020-206
	Item no.: 2020-206/000-039 2-conductor female connector; 1.5 mm ² ; 6-pole; 1,50 mm ² ; green-yellow, blue, gray	/000-039	2020-206
	Item no.: 2020-207 2-conductor female connector; 1.5 mm ² ; 7-pole; 1,50 mm ² ; gray		2020-207
	Item no.: 2020-207/000-036 2-conductor female connector; 1.5 mm ² ; 7-pole; 1,50 mm ² ; gray, green-yellow	/000-036	2020-207



















	Item no.: 2020-207/000-037 2-conductor female connector; 1.5 mm ² ; 7-pole; 1,50 mm ² ; green-yellow, gray	2020-207
		/000-037
	Item no.: 2020-207/000-038 2-conductor female connector; 1.5 mm ² ; 7-pole; 1,50 mm ² ; gray, blue, green-yellow	2020-207
		/000-038
	Item no.: 2020-207/000-039 2-conductor female connector; 1.5 mm ² ; 7-pole; 1,50 mm ² ; green-yellow, blue, gray	2020-207
		/000-039
	Item no.: 2020-208 2-conductor female connector; 1.5 mm ² ; 8-pole; 1,50 mm ² ; gray	2020-208
	Item no.: 2020-208/000-036 2-conductor female connector; 1.5 mm ² ; 8-pole; 1,50 mm ² ; gray, green-yellow	2020-208
		/000-036
	Item no.: 2020-208/000-037 2-conductor female connector; 1.5 mm ² ; 8-pole; 1,50 mm ² ; green-yellow, gray	2020-208
		/000-037
	Item no.: 2020-208/000-038 2-conductor female connector; 1.5 mm ² ; 8-pole; 1,50 mm ² ; gray, blue, green-yellow	2020-208
		/000-038
	Item no.: 2020-208/000-039 2-conductor female connector; 1.5 mm ² ; 8-pole; 1,50 mm ² ; green-yellow, blue, gray	2020-208
		/000-039
	Item no.: 2020-209 2-conductor female connector; 1.5 mm ² ; 9-pole; 1,50 mm ² ; gray	2020-209
	Item no.: 2020-209/000-036 2-conductor female connector; 1.5 mm ² ; 9-pole; 1,50 mm ² ; gray, green-yellow	2020-209
		/000-036
	Item no.: 2020-209/000-037 2-conductor female connector; 1.5 mm ² ; 9-pole; 1,50 mm ² ; green-yellow, gray	2020-209
		/000-037
	Item no.: 2020-209/000-038 2-conductor female connector; 1.5 mm ² ; 9-pole; 1,50 mm ² ; gray, blue, green-yellow	2020-209
		/000-038
	Item no.: 2020-209/000-039 2-conductor female connector; 1.5 mm ² ; 9-pole; 1,50 mm ² ; green-yellow, blue, gray	2020-209
		/000-039
	Item no.: 2020-210 2-conductor female connector; 1.5 mm ² ; 10-pole; 1,50 mm ² ; gray	2020-210
	Item no.: 2020-210/000-036 2-conductor female connector; 1.5 mm ² ; 10-pole; 1,50 mm ² ; gray, green-yellow	2020-210
		/000-036





	Item no.: 2020-210/000-037 2-conductor female connector; 1.5 mm ² ; 10-pole; 1,50 mm2; green-yellow, gray	/000-037	2020-210
	Item no.: 2020-210/000-038 2-conductor female connector; 1.5 mm ² ; 10-pole; 1,50 mm2; gray, blue, green-yellow	/000-038	2020-210
	Item no.: 2020-210/000-039 2-conductor female connector; 1.5 mm ² ; 10-pole; 1,50 mm2; green-yellow, blue, gray	/000-039	2020-210
	Item no.: 2020-211 2-conductor female connector; 1.5 mm ² ; 11-pole; 1,50 mm2; gray		2020-211
	Item no.: 2020-211/000-036 2-conductor female connector; 1.5 mm ² ; 11-pole; 1,50 mm2; gray, green-yellow	/000-036	2020-211
	Item no.: 2020-211/000-037 2-conductor female connector; 1.5 mm ² ; 11-pole; 1,50 mm2; green-yellow, gray	/000-037	2020-211
	Item no.: 2020-211/000-038 2-conductor female connector; 1.5 mm ² ; 11-pole; 1,50 mm2; gray, blue, green-yellow	/000-038	2020-211
	Item no.: 2020-211/000-039 2-conductor female connector; 1.5 mm ² ; 11-pole; 1,50 mm2; green-yellow, blue, gray	/000-039	2020-211
	Item no.: 2020-212 2-conductor female connector; 1.5 mm ² ; 12-pole; 1,50 mm2; gray		2020-212
	Item no.: 2020-212/000-036 2-conductor female connector; 1.5 mm ² ; 12-pole; 1,50 mm2; gray, green-yellow	/000-036	2020-212
	Item no.: 2020-212/000-037 2-conductor female connector; 1.5 mm ² ; 12-pole; 1,50 mm2; green-yellow, gray	/000-037	2020-212
	Item no.: 2020-212/000-038 2-conductor female connector; 1.5 mm ² ; 12-pole; 1,50 mm2; gray, blue, green-yellow	/000-038	2020-212
	Item no.: 2020-212/000-039 2-conductor female connector; 1.5 mm ² ; 12-pole; 1,50 mm2; green-yellow, blue, gray	/000-039	2020-212
	Item no.: 2020-213 2-conductor female connector; 1.5 mm ² ; 13-pole; 1,50 mm2; gray		2020-213
	Item no.: 2020-213/000-036 2-conductor female connector; 1.5 mm ² ; 13-pole; 1,50 mm2; gray, green-yellow	/000-036	2020-213

	Item no.: 2020-213/000-037 2-conductor female connector; 1.5 mm ² ; 13-pole; 1,50 mm2; green-yellow, gray	/000-037	2020-213
	Item no.: 2020-213/000-038 2-conductor female connector; 1.5 mm ² ; 13-pole; 1,50 mm2; gray, blue, green-yellow	/000-038	2020-213
	Item no.: 2020-213/000-039 2-conductor female connector; 1.5 mm ² ; 13-pole; 1,50 mm2; green-yellow, blue, gray	/000-039	2020-213
	Item no.: 2020-214 2-conductor female connector; 1.5 mm ² ; 14-pole; 1,50 mm2; gray		2020-214
	Item no.: 2020-214/000-036 2-conductor female connector; 1.5 mm ² ; 14-pole; 1,50 mm2; gray, green-yellow	/000-036	2020-214
	Item no.: 2020-214/000-037 2-conductor female connector; 1.5 mm ² ; 14-pole; 1,50 mm2; green-yellow, gray	/000-037	2020-214
	Item no.: 2020-214/000-038 2-conductor female connector; 1.5 mm ² ; 14-pole; 1,50 mm2; gray, blue, green-yellow	/000-038	2020-214
	Item no.: 2020-214/000-039 2-conductor female connector; 1.5 mm ² ; 14-pole; 1,50 mm2; green-yellow, blue, gray	/000-039	2020-214
	Item no.: 2020-215 2-conductor female connector; 1.5 mm ² ; 15-pole; 1,50 mm2; gray		2020-215
	Item no.: 2020-215/000-036 2-conductor female connector; 1.5 mm ² ; 15-pole; 1,50 mm2; gray, green-yellow	/000-036	2020-215
	Item no.: 2020-215/000-037 2-conductor female connector; 1.5 mm ² ; 15-pole; 1,50 mm2; green-yellow, gray	/000-037	2020-215
	Item no.: 2020-215/000-038 2-conductor female connector; 1.5 mm ² ; 15-pole; 1,50 mm2; gray, blue, green-yellow	/000-038	2020-215
	Item no.: 2020-215/000-039 2-conductor female connector; 1.5 mm ² ; 15-pole; 1,50 mm2; green-yellow, blue, gray	/000-039	2020-215
Jumper			
	Item no.: 2000-402 Push-in type jumper bar; insulated; 2-way; Nominal current 14 A; light gray		2000-402
	Item no.: 2000-402/000-005 Push-in type jumper bar; insulated; 2-way; Nominal current 14 A; red	/000-005	2000-402

	Item no.: 2000-402/000-006 Push-in type jumper bar; insulated; 2-way; Nominal current 14 A; blue	2000-402
	Item no.: 2000-402/000-018 Push-in type jumper bar; insulated; 2-way; Nominal current 14 A; yellow-green	2000-402
	Item no.: 2000-403 Push-in type jumper bar; insulated; 3-way; Nominal current 14 A; light gray	2000-403
	Item no.: 2000-403/000-005 Push-in type jumper bar; insulated; 3-way; Nominal current 14 A; red	2000-403
	Item no.: 2000-403/000-006 Push-in type jumper bar; insulated; 3-way; Nominal current 14 A; blue	2000-403
	Item no.: 2000-404 Push-in type jumper bar; insulated; 4-way; Nominal current 14 A; light gray	2000-404
	Item no.: 2000-404/000-005 Push-in type jumper bar; insulated; 4-way; Nominal current 14 A; red	2000-404
	Item no.: 2000-404/000-006 Push-in type jumper bar; insulated; 4-way; Nominal current 14 A; blue	2000-404
	Item no.: 2000-405 Push-in type jumper bar; insulated; 5-way; Nominal current 14 A; light gray	2000-405
	Item no.: 2000-405/000-005 Push-in type jumper bar; insulated; 5-way; Nominal current 14 A; red	2000-405
	Item no.: 2000-405/000-006 Push-in type jumper bar; insulated; 5-way; Nominal current 14 A; blue	2000-405
	Item no.: 2000-405/011-000 Star point jumper; insulated; 3-way (1-3-5); IN = IN terminal block; light gray	2000-405
	Item no.: 2000-406 Push-in type jumper bar; insulated; 6-way; Nominal current 14 A; light gray	2000-406
	Item no.: 2000-406/000-005 Push-in type jumper bar; insulated; 6-way; Nominal current 14 A; red	2000-406
	Item no.: 2000-406/000-006 Push-in type jumper bar; insulated; 6-way; Nominal current 14 A; blue	2000-406
	Item no.: 2000-406/020-000 Delta jumper; insulated; 1-2 3-4 5-6; IN = IN terminal block; light gray	2000-406

	Item no.: 2000-407 Push-in type jumper bar; insulated; 7-way; Nominal current 14 A; light gray		2000-407
	Item no.: 2000-407/000-005 Push-in type jumper bar; insulated; 7-way; Nominal current 14 A; red	/000-005	2000-407
	Item no.: 2000-407/000-006 Push-in type jumper bar; insulated; 7-way; Nominal current 14 A; blue	/000-006	2000-407
	Item no.: 2000-408 Push-in type jumper bar; insulated; 8-way; Nominal current 14 A; light gray		2000-408
	Item no.: 2000-408/000-005 Push-in type jumper bar; insulated; 8-way; Nominal current 14 A; red	/000-005	2000-408
	Item no.: 2000-408/000-006 Push-in type jumper bar; insulated; 8-way; Nominal current 14 A; blue	/000-006	2000-408
	Item no.: 2000-409 Push-in type jumper bar; insulated; 9-way; Nominal current 14 A; light gray		2000-409
	Item no.: 2000-409/000-005 Push-in type jumper bar; insulated; 9-way; Nominal current 14 A; red	/000-005	2000-409
	Item no.: 2000-409/000-006 Push-in type jumper bar; insulated; 9-way; Nominal current 14 A; blue	/000-006	2000-409
	Item no.: 2000-410 Push-in type jumper bar; insulated; 10-way; Nominal current 14 A; light gray		2000-410
	Item no.: 2000-410/000-005 Push-in type jumper bar; insulated; 10-way; Nominal current 14 A; red	/000-005	2000-410
	Item no.: 2000-410/000-006 Push-in type jumper bar; insulated; 10-way; Nominal current 14 A; blue	/000-006	2000-410
	Item no.: 2000-433 Push-in type jumper bar; insulated; from 1 to 3; Nominal current 14 A; light gray		2000-433
	Item no.: 2000-433/000-005 Push-in type jumper bar; insulated; from 1 to 3; Nominal current 14 A; red	/000-005	2000-433
	Item no.: 2000-433/000-006 Push-in type jumper bar; insulated; from 1 to 3; Nominal current 14 A; blue	/000-006	2000-433
	Item no.: 2000-434 Push-in type jumper bar; insulated; from 1 to 4; Nominal current 14 A; light gray		2000-434

	Item no.: 2000-435 Push-in type jumper bar; insulated; from 1 to 5; Nominal current 14 A; light gray	2000-435
	Item no.: 2000-436 Push-in type jumper bar; insulated; from 1 to 6; Nominal current 14 A; light gray	2000-436
	Item no.: 2000-437 Push-in type jumper bar; insulated; from 1 to 7; Nominal current 14 A; light gray	2000-437
	Item no.: 2000-438 Push-in type jumper bar; insulated; from 1 to 8; Nominal current 14 A; light gray	2000-438
	Item no.: 2000-439 Push-in type jumper bar; insulated; from 1 to 9; Nominal current 14 A; light gray	2000-439
	Item no.: 2000-440 Push-in type jumper bar; insulated; from 1 to 10; Nominal current 14 A; light gray	2000-440
	Item no.: 2009-402 Push-in type wire jumper; insulated; wire length 60 mm; Conductor cross section 0.75 mm ² ; suitable for 2000 and 2020 Series rail-mounted terminal blocks; gray	2009-402
	Item no.: 2009-404 Push-in type wire jumper; insulated; wire length 110 mm; Conductor cross section 0.75 mm ² ; suitable for 2000 and 2020 Series rail-mounted terminal blocks; gray	2009-404
	Item no.: 2009-406 Push-in type wire jumper; insulated; wire length 250 mm; Conductor cross section 0.75 mm ² ; suitable for 2000 and 2020 Series rail-mounted terminal blocks; gray	2009-406
	Item no.: 210-103 Wire commoning chain; insulated; 50 connections; black	210-103
	Item no.: 210-123 Wire commoning chain; insulated; 50 connections	210-123
ferrule		
	Item no.: 216-241 Ferrule; Sleeve for 0.5 mm ² / 20 AWG; insulated; electro-tin plated; electrolytic copper; gastight crimped; acc. to DIN 46228, Part 4/09.90; white	216-241
	Item no.: 216-242 Ferrule; Sleeve for 0.75 mm ² / 18 AWG; insulated; electro-tin plated; electrolytic copper; gastight crimped; acc. to DIN 46228, Part 4/09.90; gray	216-242
	Item no.: 216-243 Ferrule; Sleeve for 1 mm ² / AWG 18; insulated; electro-tin plated; electrolytic copper; gastight crimped; acc. to DIN 46228, Part 4/09.90; red	216-243
Carrier rail		
	Item no.: 210-112 Steel carrier rail; 35 x 7.5 mm; 1 mm thick; 2 m long; slotted; according to EN 60715; "Hole width 25 mm	210-112
	Item no.: 210-113 Steel carrier rail; 35 x 7.5 mm; 1 mm thick; 2 m long; unslotted; according to EN 60715	210-113
	Item no.: 210-114 Steel carrier rail; 35 x 15 mm; 1.5 mm thick; 2 m long; unslotted; similar to EN 60715	210-114
	Item no.: 210-115 Steel carrier rail; 35 x 7.5 mm; 1 mm thick; 2 m long; slotted; according to EN 60715; "Hole width 18 mm	210-115

	Item no.: 210-118 Steel carrier rail; 35 x 15 mm; 2.3 mm thick; 2 m long; unslotted; according to EN 60715	210-118
	Item no.: 210-196 Aluminum carrier rail; 35 x 8.2 mm; 1.6 mm thick; 2 m long; unslotted; similar to EN 60715; silver-colored	210-196
	Item no.: 210-197 Steel carrier rail; 35 x 15 mm; 1.5 mm thick; 2 m long; slotted; similar to EN 60715	210-197
	Item no.: 210-198 Copper carrier rail; 35 x 15 mm; 2.3 mm thick; 2 m long; unslotted; according to EN 60715; copper-colored	210-198

Downloads

Documentation

Bid Text

2020-5372		doc 26.1 kB	Download
-----------	--	----------------	----------

Additional Information

Technical explanations	Apr 3, 2019	pdf 2.1 MB	Download
------------------------	-------------	---------------	----------

CAD/CAE - Smart Data

CAD data

3D Download 2020-5372		URL	Download
-----------------------	--	-----	----------

Subject to changes.